

Data sheet | Item number: 2060-962/028-000

Board-to-Board Link; Pin spacing 8 mm; 2-pole; Length: 28 mm

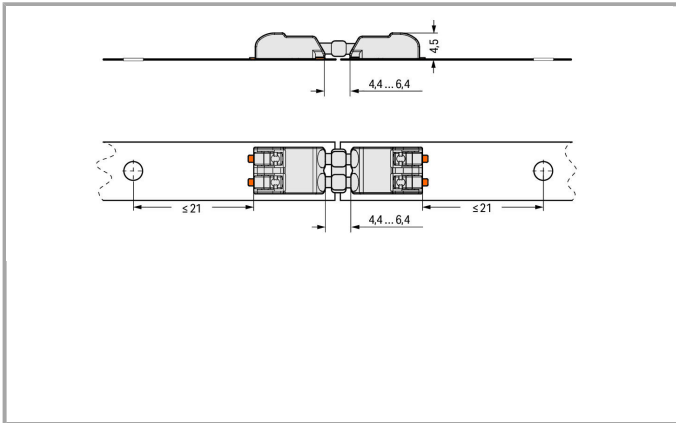

2060-962/028-000

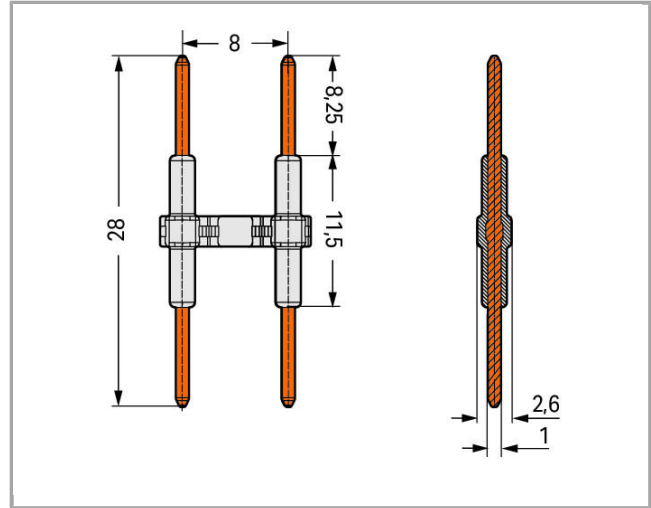
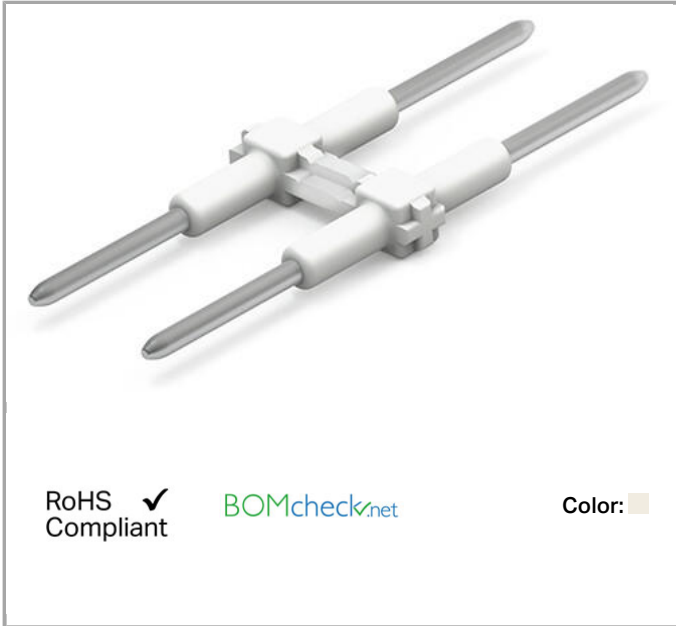

Item description

- Board-to-board link simplifies in-line assembly of LED modules
- Easy push-in termination and disconnection without push-button actuation

Recommendation:

Only suitable for 2060-852, not for 2060-802

Data

Electrical data

Ratings per IEC/EN 60664-1

Rated voltage (III / 3)	400 V
Rated impulse voltage (III / 3)	6 kV
Rated voltage (III / 2)	630 V
Rated impulse voltage (III / 2)	6 kV
Rated voltage (II / 2)	1000 V
Rated impulse voltage (II / 2)	6 kV
Rated current	9 A

Approvals per UL 1977

Rated voltage per UL 1977 (factory wiring only)	600 V
Rated current per UL 1977 (factory wiring only)	9 A

Connection data

No. of poles	2
Total number of potentials	2
Number of connection types	1

Geometrical Data

Pin spacing	8 mm / 0.314 inch
Width	11.4 mm / 0.449 inch
Height	2.6 mm / 0.102 inch
Depth	28 mm / 1.102 inch

Mechanical data

Mating cycles	10
Number of mating cycles	max. 10 mating cycles

Material Data

Color	white
Material group	I
Insulating material	Polyamide 66 (PA 66)

Flammability class per UL94	V0
Contact material	Copper alloy
Contact plating	silver-plated
Fire load	0MJ
Weight	0.49 g

Environmental Requirements







Limit temperature range	-60 ... +105 °C
-------------------------	-----------------

Commercial data

Country of origin	CN
GTIN	4055143322898
Customs Tariff No.	85369010000

Approvals / Certificates

Country specific Approvals

Logo	Approval	Additional Approval Text	Certificate name
	CCA DEKRA Certification B.V.	EN 60947	NTR NL- 7724
	CCA DEKRA Certification B.V.	EN 60998	NTR NL 7725
	CCA DEKRA Certification B.V.	EN 60998	71-107169
	CCA DEKRA Certification B.V.	EN 60838	NTR NL 2168246
	KEMA/KEUR DEKRA Certification B.V.	EN 60947	71-107168
	KEMA/KEUR DEKRA Certification B.V.	EN 60838	2168246.01

UL-Approvals



Logo	Approval	Additional Approval Text	Certificate name
	cURus Underwriters Laboratories Inc.	UL 1977	E45171

Downloads

Documentation

Additional Information

pdf
3.6 MB
Download

CAD/CAE - Smart Data

CAD data

3D Download 2060-962/028-000
URL
Download

Subject to changes.